

DIN 3129.

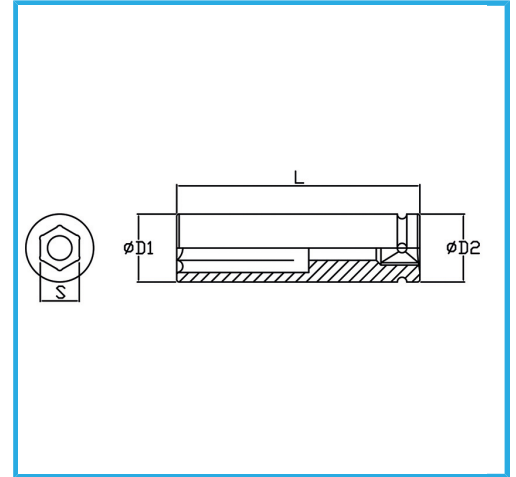

Size	42 mm
D1	64 mm
D2	54 mm
Length	95 mm
Gross weight	1,24 kg
EAN Code	8012667273361



Phosphated



1"



-



Cr-Mo

-