

DIN 3129.

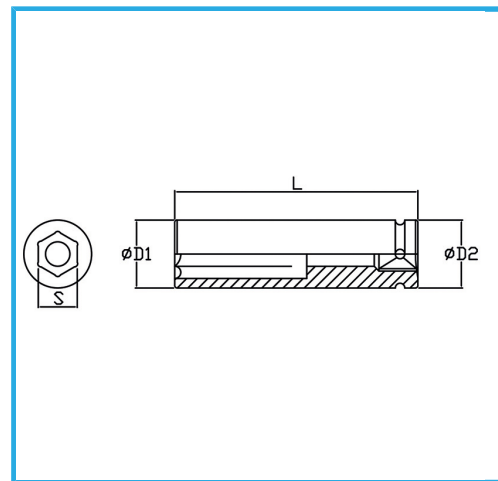

€35,90

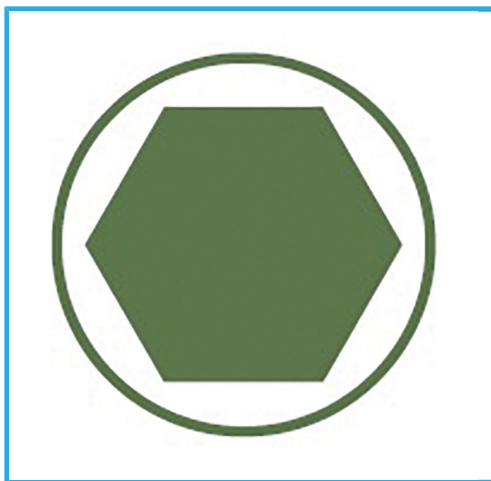

Misura	42 mm
D1	64 mm
D2	54 mm
Lunghezza	95 mm
Peso lordo	1,24 kg
Dimensioni imballo	65x65x95 h mm
Codice EAN	8012667273361



Fosfatata



1"



Cr-Mo