

DIN 3129.

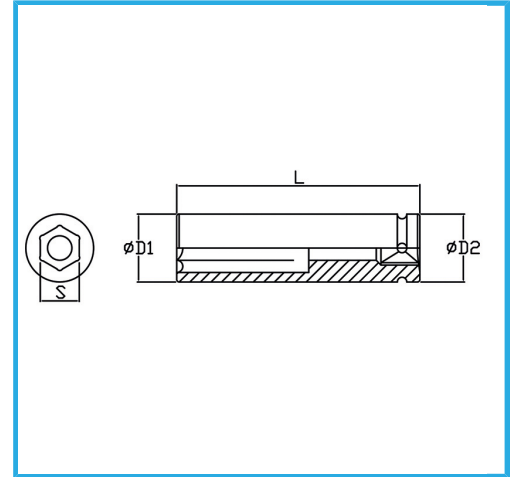

Size	44 mm
D1	66 mm
D2	54 mm
Length	95 mm
Gross weight	1,30 kg
EAN Code	8012667273385



Phosphated



1"



-



Cr-Mo