

DIN 3129.

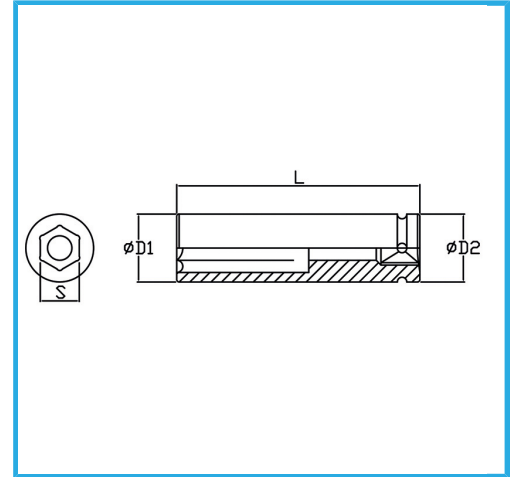

Size	46 mm
D1	68 mm
D2	54 mm
Length	95 mm
Gross weight	1,31 kg
EAN Code	8012667273408



Phosphated



1"



-



-