

DIN 3129.

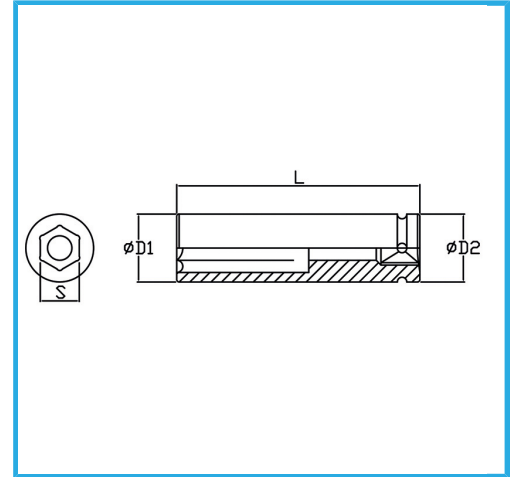

<b>Size</b>	51 mm
<b>D1</b>	74 mm
<b>D2</b>	54 mm
<b>Length</b>	100 mm
<b>Gross weight</b>	1,63 kg
<b>EAN Code</b>	8012667273439



Phosphated



1"



-



Cr-Mo

-