

DIN 3129.

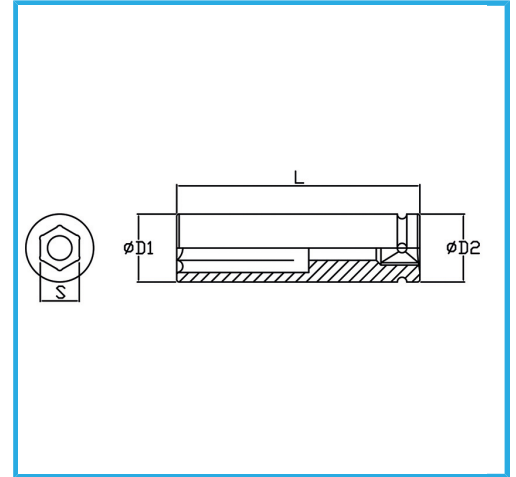

Size	55 mm
D1	80 mm
D2	54 mm
Length	105 mm
Gross weight	1,87 kg
EAN Code	8012667272951



Phosphated



1"



Cr-Mo