

DIN 3129.

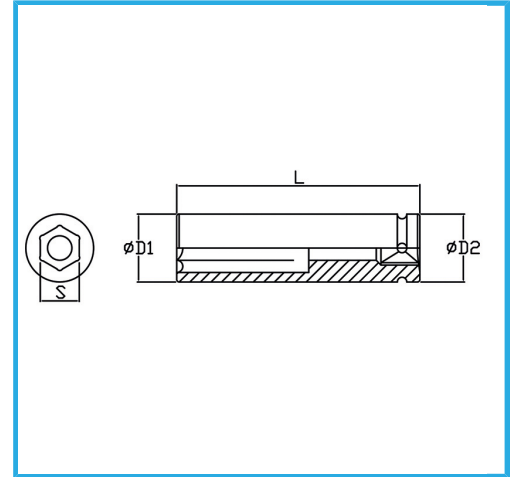

<b>Size</b>	57 mm
<b>D1</b>	82 mm
<b>D2</b>	54 mm
<b>Length</b>	105 mm
<b>Gross weight</b>	1,95 kg
<b>EAN Code</b>	8012667272968



Phosphated



1"



-



Cr-Mo

-