

DIN 3129.

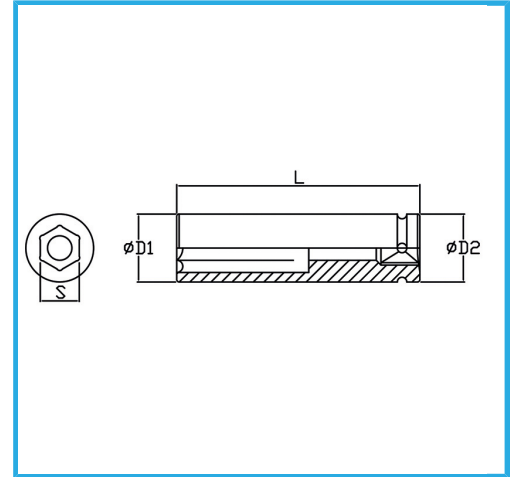

Size	60 mm
D1	86 mm
D2	54 mm
Length	110 mm
Gross weight	2,10 kg
EAN Code	8012667272975



Phosphated



1"



Cr-Mo