

DIN 3129.

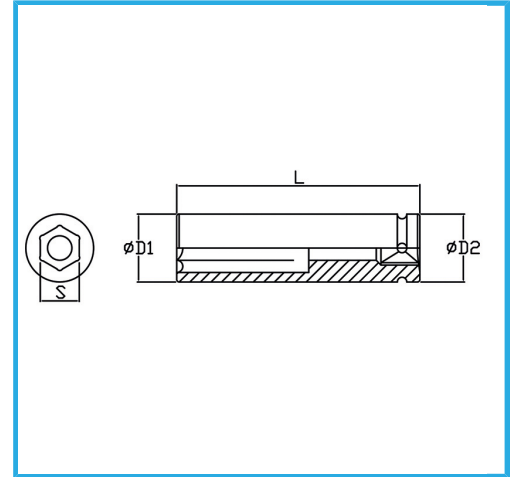

Size	65 mm
D1	92 mm
D2	54 mm
Length	115 mm
Gross weight	2,47 kg
EAN Code	8012667273460



Phosphated



1"



-



Cr-Mo

-