

DIN 3129.

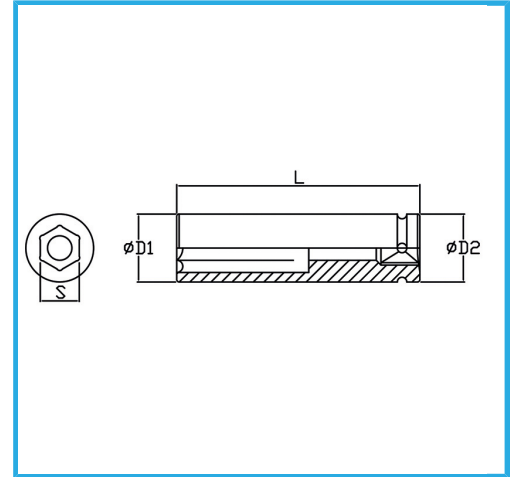

Size	70 mm
D1	97 mm
D2	54 mm
Length	120 mm
Gross weight	2,93 kg
EAN Code	8012667272982



Phosphated



1"



-



Cr-Mo

-