

DIN 3129.

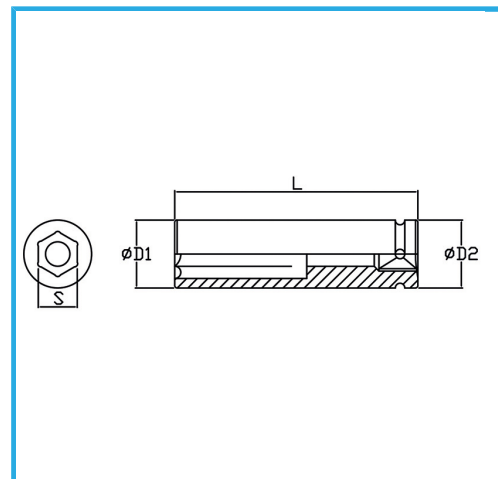

Size	80 mm
D1	112 mm
D2	86 mm
Length	135 mm
Gross weight	4,50 kg
EAN Code	8012667273477



Phosphated



1"



-



Cr-Mo

-