

DIN 3129.

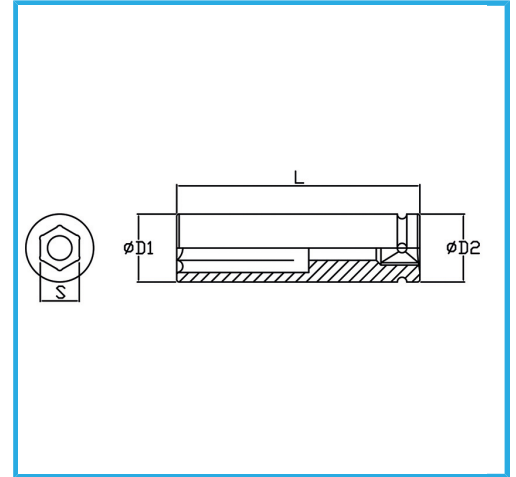

Size	90 mm
D1	124 mm
D2	86 mm
Length	140 mm
Gross weight	6,13 kg
EAN Code	8012667273491



Phosphated



1"



-



Cr-Mo

-