

ART. BI423L040
LLAVE DE VASO DE IMPACTO CON PUNTA TORX MACHO

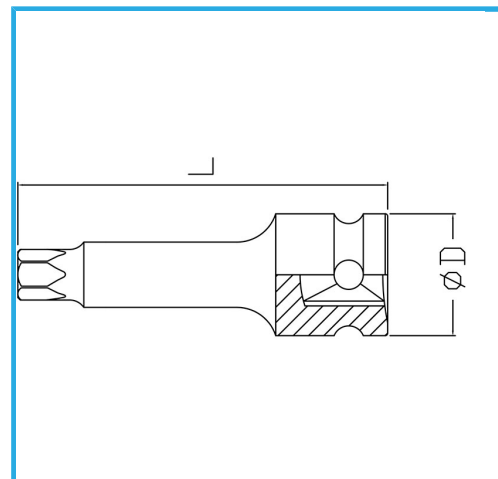

€8,00



Medida	T40
D	25 mm
Longitud	78 mm
Peso bruto	0,09 kg
Codigo de barras	8012667271268



Fosfatado



1/2"



Cr-Mo