

€15,00

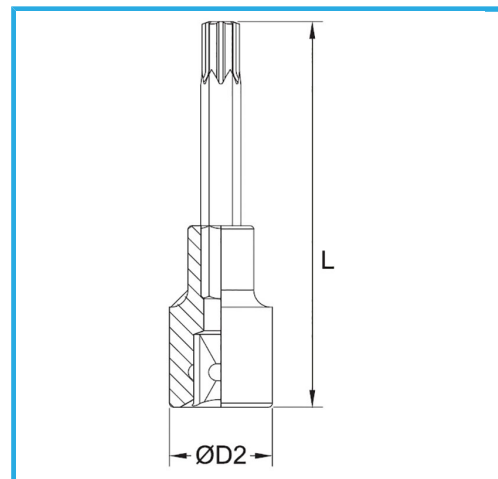

Misura	T45
D2	18 mm
Lunghezza	95 mm
Peso lordo	0,05 kg
Codice EAN	8012667281878



Append.



-



Cr-V

-



Cromata



3/8"