

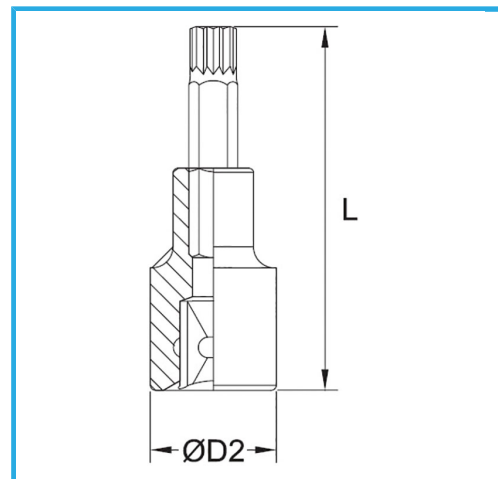

€9,00



Misura
D2
Lunghezza
Peso lordo
Codice EAN

M 9
22 mm
55 mm
0,08 kg
8012667282738



Append.



-



Cr-V

-



Cromata



1/2"