

ERMÖGLICHT EINEN SEHR SCHNELLEN SCHNITT, ERFORDERT KEIN VORBOHREN UND VERMEIDET GRATBILDUNG DURCH DEN GERINGEREN...

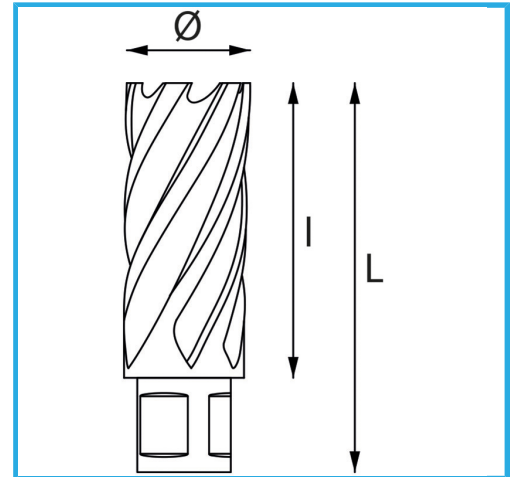

Ø	13 mm
Schnittkapazität	30 mm
Gesamtlänge	62 mm
Bruttogewicht	0,08 kg
Verpackungsmaße	30 x 30 x 100 h mm
EAN-Code	8012667291259

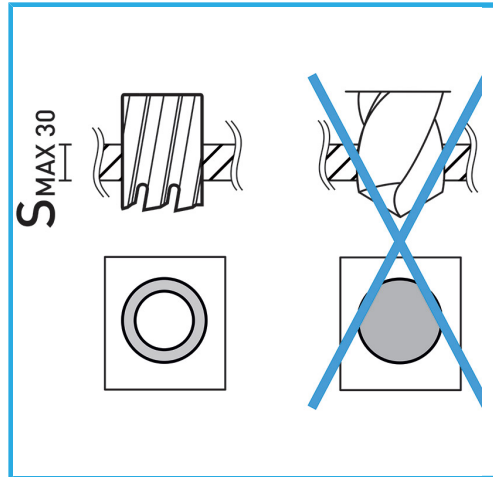

Aufhängbar

HSS
CO 5%