

ERMÖGLICHT EINEN SEHR SCHNELLEN SCHNITT, ERFORDERT KEIN VORBOHREN UND VERMEIDET GRATBILDUNG DURCH DEN GERINGEREN...

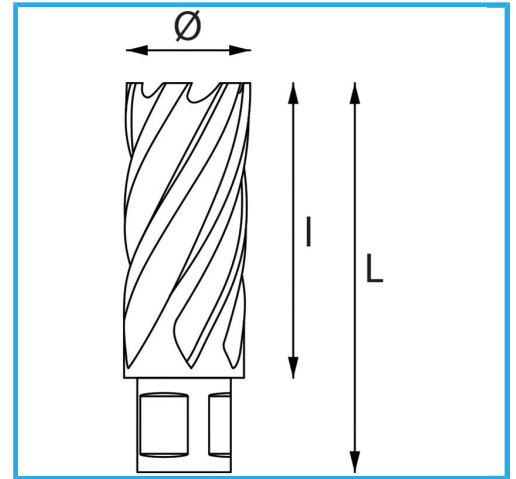

Ø	18 mm
Schnittkapazität	30 mm
Gesamtlänge	62 mm
Bruttogewicht	0,09 kg
Verpackungsmaße	100x30x30 h mm
EAN-Code	8012667291303

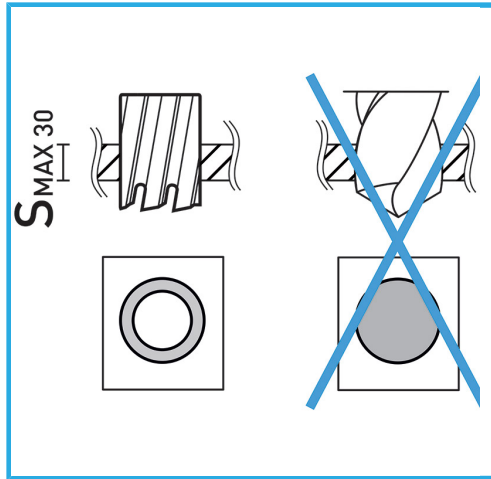

Aufhängbar

HSS
CO 5%