

ALLOWS A VERY FAST CUT, DOES NOT REQUIRE PRE-DRILLING AND DOES NOT CREATE ANY BURR FORMATION THANKS TO THE LOWER EFFORT OF THE...

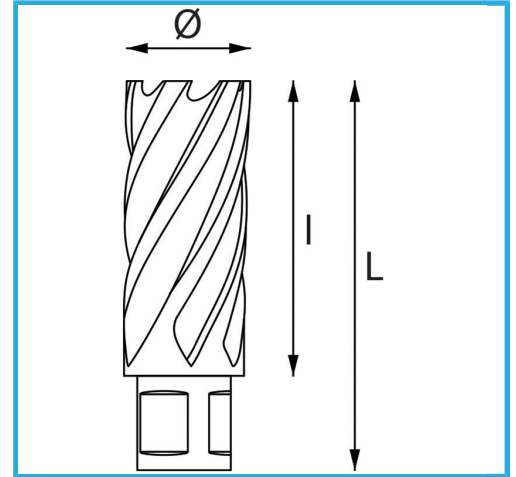

Ø	18 mm
Cutting capacity	30 mm
Total length	62 mm
Gross weight	0,09 kg
EAN Code	8012667291303

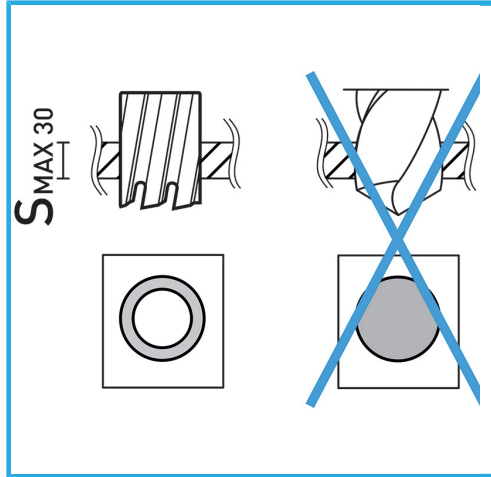

Hangable

HSS
CO 5%