

ERMÖGLICHT EINEN SEHR SCHNELLEN SCHNITT, ERFORDERT KEIN VORBOHREN UND VERMEIDET GRATBILDUNG DURCH DEN GERINGEREN...

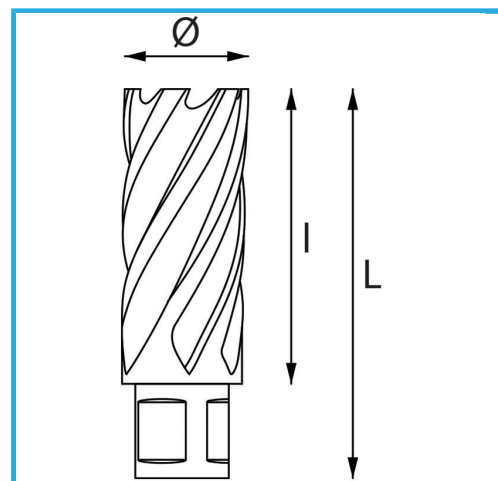

Ø	19 mm
Schnittkapazität	30 mm
Gesamtlänge	62 mm
Bruttogewicht	0,10 kg
EAN-Code	8012667291310

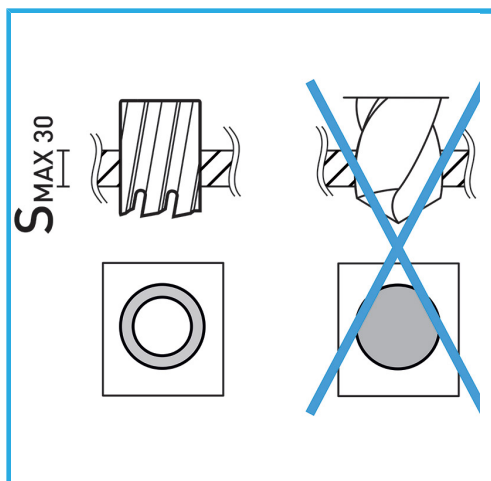

Aufhängbar

HSS
CO 5%