

ERMÖGLICHT EINEN SEHR SCHNELLEN SCHNITT, ERFORDERT KEIN  
VORBOHREN UND VERMEIDET GRATBILDUNG DURCH DEN  
GERINGEREN...

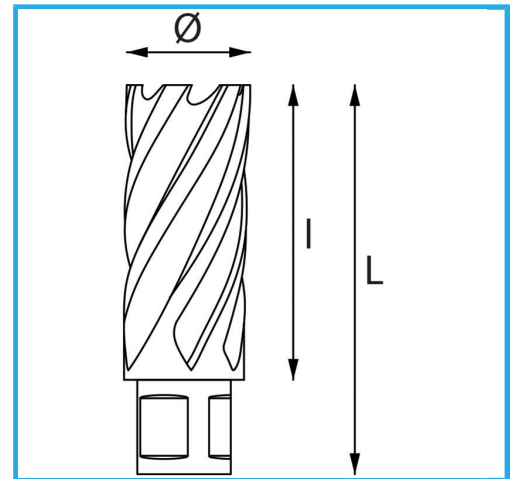

Ø	22 mm
Schnittkapazität	30 mm
Gesamtlänge	62 mm
Bruttogewicht	0,11 kg
Verpackungsmaße	30x30x100 h mm
EAN-Code	8012667291341

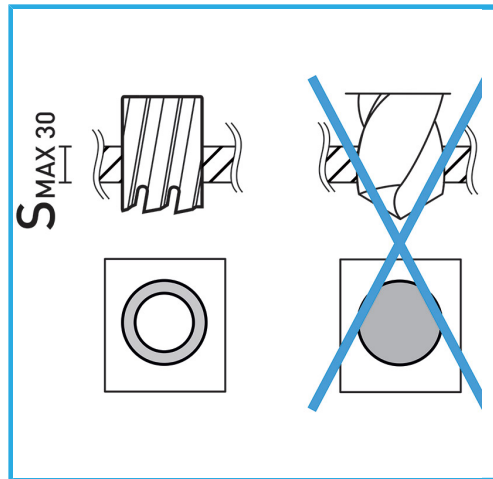

Aufhängbar

HSS  
CO 5%