

ALLOWS A VERY FAST CUT, DOES NOT REQUIRE PRE-DRILLING AND DOES NOT CREATE ANY BURR FORMATION THANKS TO THE LOWER EFFORT OF THE...

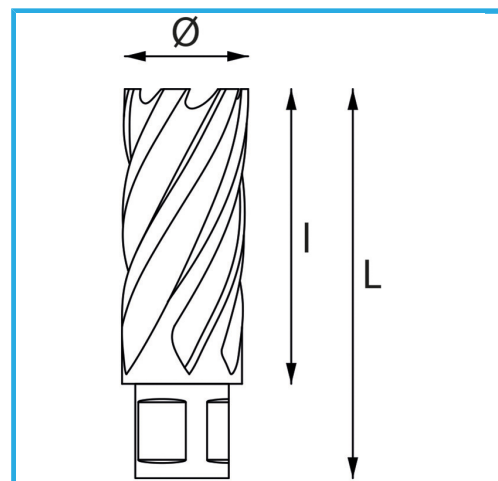

Ø	25 mm
Cutting capacity	50 mm
Total length	85 mm
Gross weight	0,16 kg
EAN Code	8012667292270

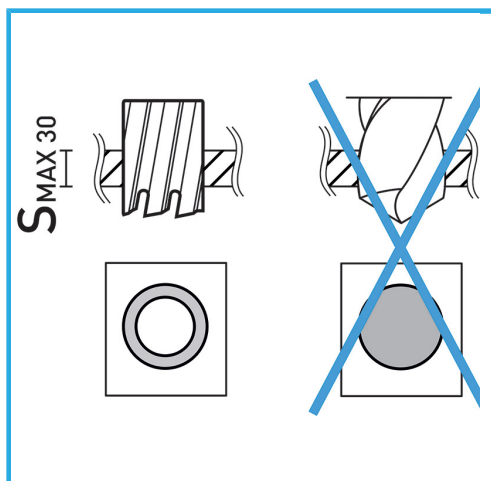

Hangable

HSS
CO 5%