

ERMÖGLICHT EINEN SEHR SCHNELLEN SCHNITT, ERFORDERT KEIN VORBOHREN UND VERMEIDET GRATBILDUNG DURCH DEN GERINGEREN...

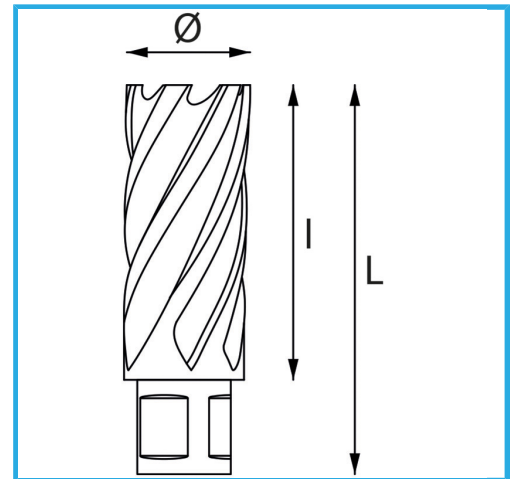

Ø	26 mm
Schnittkapazität	30 mm
Gesamtlänge	62 mm
Bruttogewicht	0,13 kg
Verpackungsmaße	105x35x35 h mm
EAN-Code	8012667291389

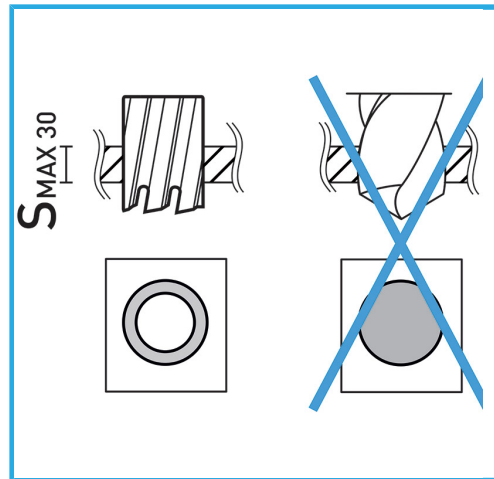

Aufhängbar

HSS
CO 5%