

ERMÖGLICHT EINEN SEHR SCHNELLEN SCHNITT, ERFORDERT KEIN VORBOHREN UND VERMEIDET GRATBILDUNG DURCH DEN GERINGEREN...

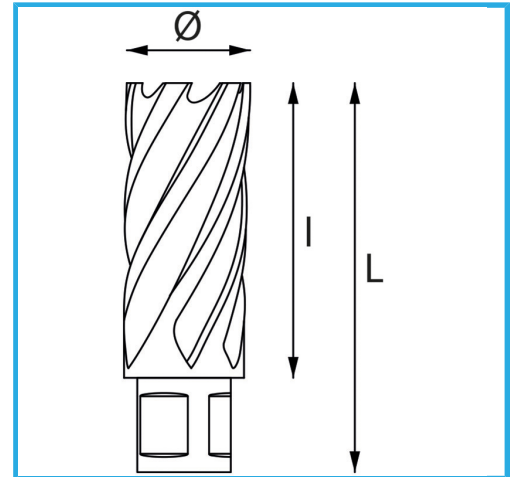

Ø	33 mm
Schnittkapazität	30 mm
Gesamtlänge	62 mm
Bruttogewicht	0,17 kg
EAN-Code	8012667291457

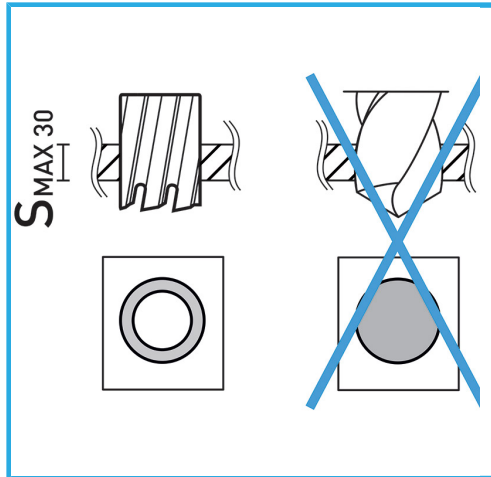

Aufhängbar

**HSS**  
CO 5%