

ERMÖGLICHT EINEN SEHR SCHNELLEN SCHNITT, ERFORDERT KEIN VORBOHREN UND VERMEIDET GRATBILDUNG DURCH DEN GERINGEREN...

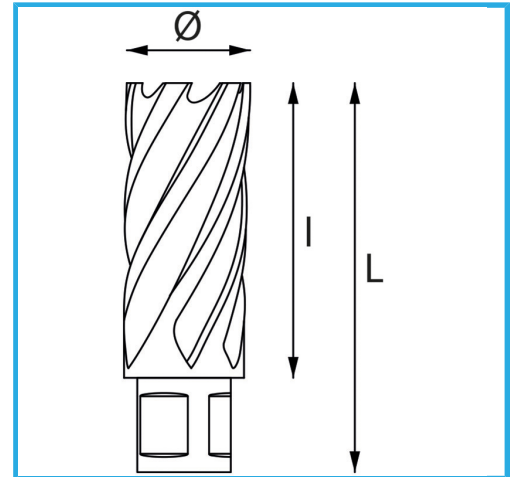

Ø	35 mm
Schnittkapazität	30 mm
Gesamtlänge	62 mm
Bruttogewicht	0,18 kg
EAN-Code	8012667291471

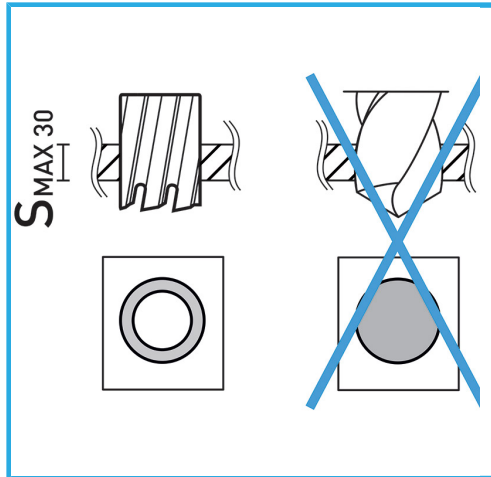

Aufhängbar

HSS  
CO 5%