

ERMÖGLICHT EINEN SEHR SCHNELLEN SCHNITT, ERFORDERT KEIN VORBOHREN UND VERMEIDET GRATBILDUNG DURCH DEN GERINGEREN...

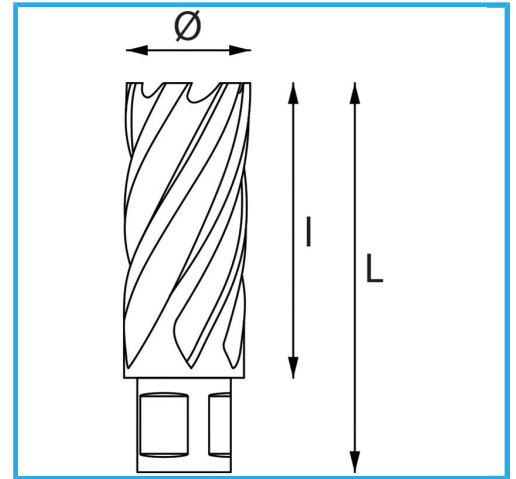

Ø	40 mm
Schnittkapazität	30 mm
Gesamtlänge	62 mm
Bruttogewicht	0,21 kg
Verpackungsmaße	105x45x45 h mm
EAN-Code	8012667291525

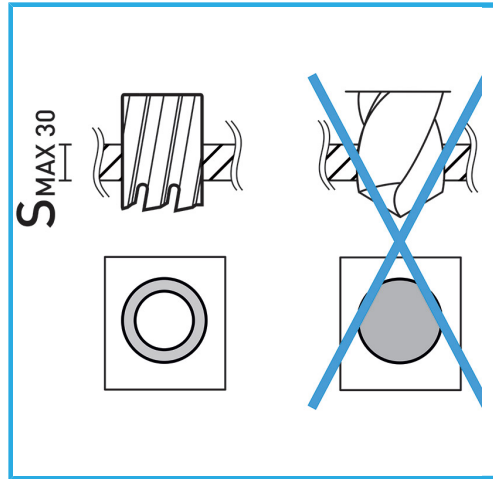

Aufhängbar

HSS
CO 5%