

ERMÖGLICHT EINEN SEHR SCHNELLEN SCHNITT, ERFORDERT KEIN VORBOHREN UND VERHINDERT GRATBILDUNG AUFGRUND DES GERINGEREN...

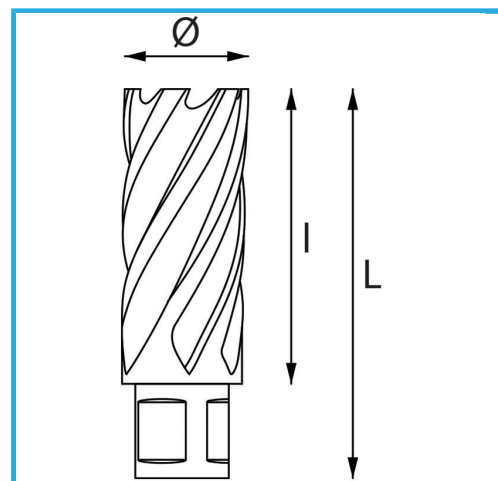

| | |
|------------------|---------------|
| Ø | 43 mm |
| Schnittkapazität | 50 mm |
| Gesamtlänge | 85 mm |
| Bruttogewicht | 0,29 kg |
| EAN-Code | 8012667292454 |

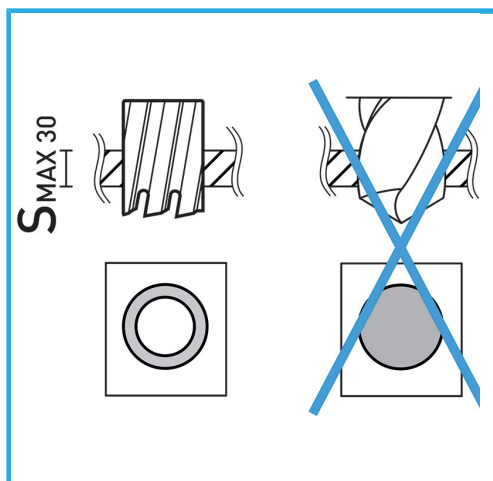

Aufhängbar

HSS
CO 5%