

ALLOWS A VERY FAST CUT, DOES NOT REQUIRE PRE-DRILLING AND DOES NOT CREATE ANY BURR FORMATION THANKS TO THE LOWER EFFORT OF THE...

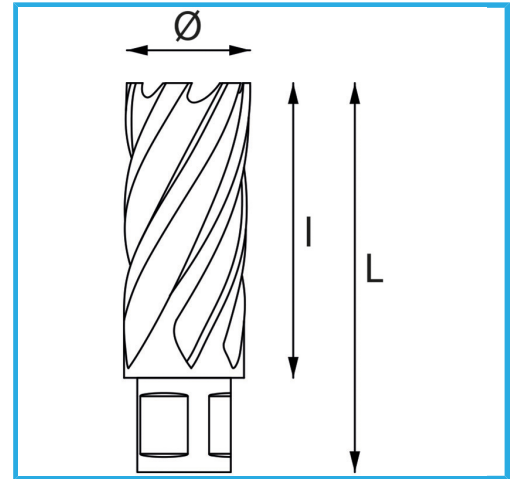
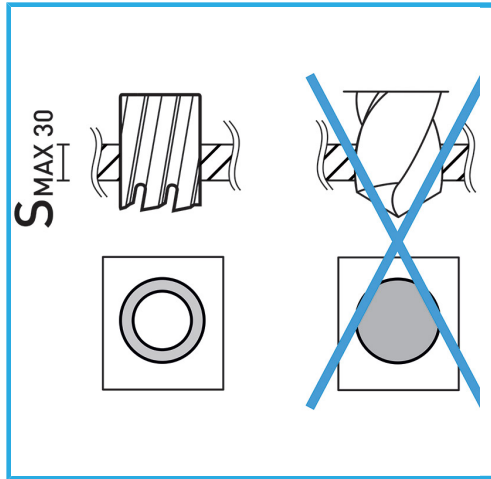

Cutting capacity

Ø

Total length

Gross weight

EAN Code

30 mm

45 mm

62 mm

0,24 kg

8012667292010



Hangable

HSS